

Yamaha Motor's First Motorcycle

# YA-1

## Assembly Instructions

Standard Edition

pack 1



### Headlight, Steering, Front Fender, Frame, etc.



Please follow these assembly instructions, cross-checking the part numbers on the parts sheet. Assemble all the parts from **pack 1** to **pack 3**.

A realistic recreation of the **YA-1**. will be the result.

This file provides assembly instructions. Please download the parts data separately.



We recommend to print out the parts data on A4 inkjet printer paper for paper craft, sturdy paper or card.

## 1 To begin

### Tools and materials needed

-Ruler - scissors - blade cutter or "Exacto-knife" - awl or other pointed tool - Embosspen - Transer (for making a folding crease) - Felt pen - pin set - Glue - Hand towel ( for cleaning your fingers) - dictionary or other heavy book( to press the papers flat).

### Items of Caution

\*Take care when using sharp or pointed objects or when using bladed cutting tools. Place a heavy sheet of paper under the paper you want to cut.

\*Use glue and other adhesives only in well-ventilated areas.

\*When printing, use a slightly reduced font size. There may be differences in dimensions, depending on the type of printer used.

## 2 How to assemble

\*Follow the working method and markings carefully.

\*Cut carefully along the outer line with cutting blade, Exacto-knife or scissors.

### One-point Advise

\*Cut carefully with cutting blade, Exacto-knife or scissors.

\*For folding parts, first use an awl or other pointed tool to make a light crease along the dotted or solid line. This will make the folds straight. Avoid making strong creases, as this will cause the paper to tear.

\*As an adhesive, white wood glue is recommended. Avoid over application as this may cause the paper to wrinkle.

\*Before beginning assembly, test adhesive amounts on extra paper.

\*Occasionally, white spots will be apparent on folds and cuts. Use a marker or pencil to fill in these spots.

It is recommended that this be done after each stage of assembly because coloring becomes more difficult once parts are assembled.

## Basic working method and markings

### Solid lines

Fold along these lines.

The printed surface should be on the outside of the folded shape.

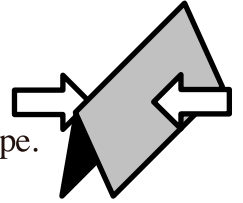

### Broken lines

Fold along these lines.

The printed surface should be on the inside of the folded shape.

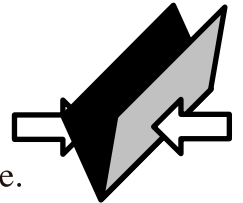

### Dotted lines

Cut along these lines.

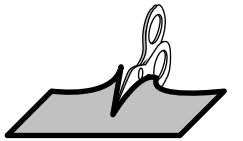

Do not fold or cut the parts marked X.

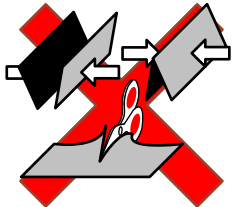

Cut out parts marked with an asterisk(\*).

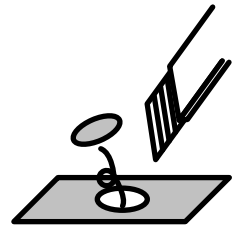

Red dots are the reference positions for gluing surfaces.

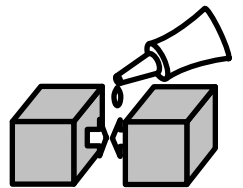

Please glue them by aligning the red and red/blue and blue parts if they are marked on the paper.

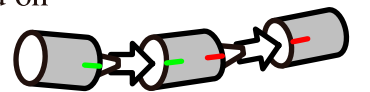

These shaded areas indicate where glue should be applied.

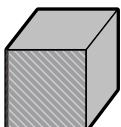

# 3 Assembly of the Headlight

Please refer to the "Basic working method and markings" symbol chart on Page 2 to assemble each part.



## Meter

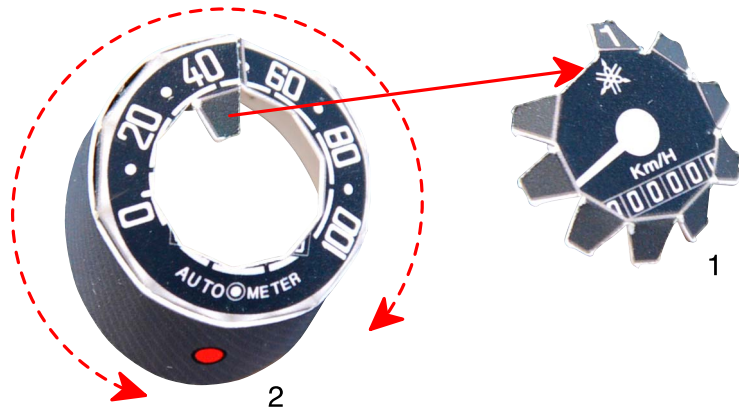

Glue in order from 1 to 9 on the graphic.

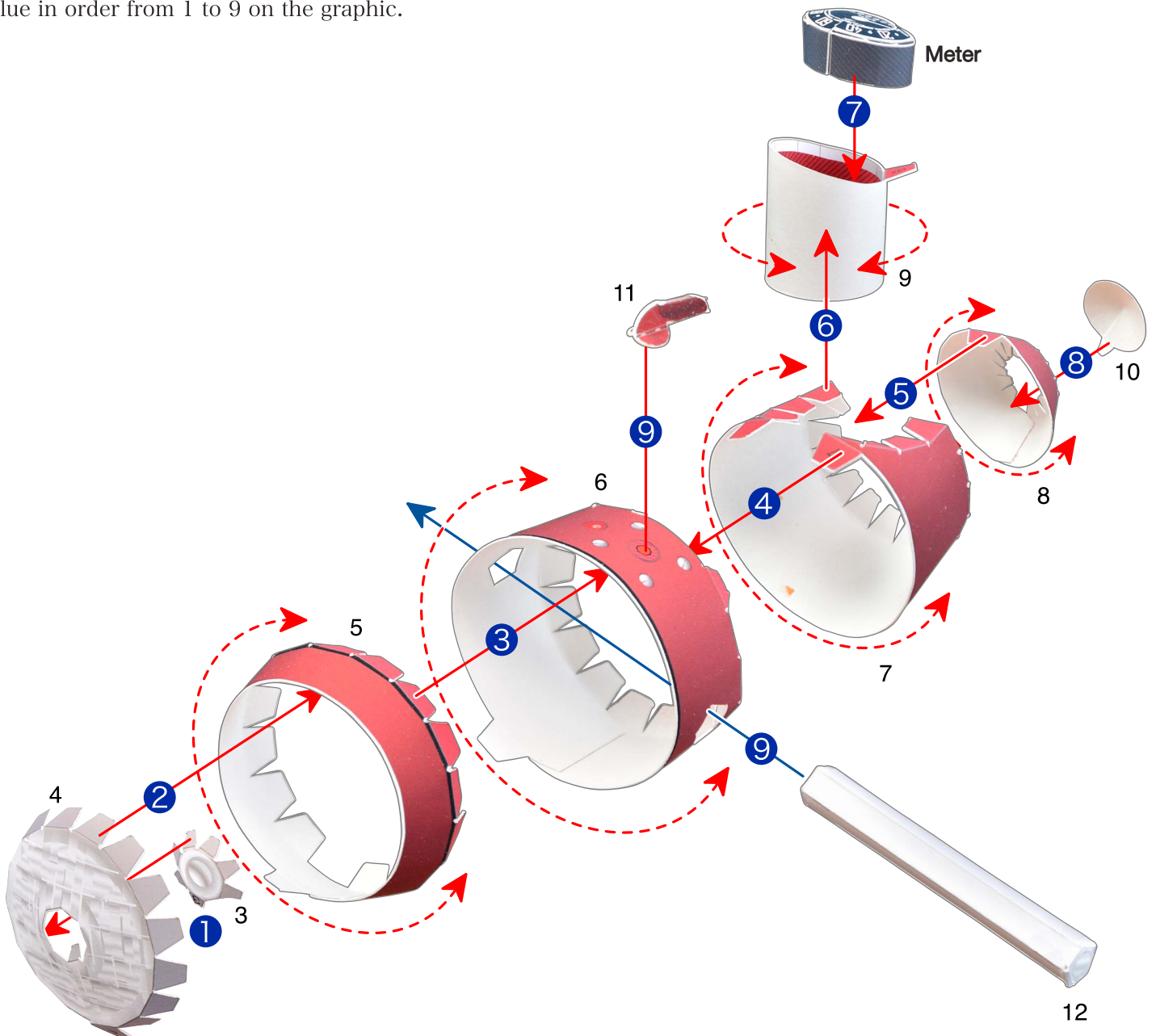

# 3 Assembly of the Steering

Please refer to the "Basic working method and markings" symbol chart on Page 2 to assemble each part.

 Fold or Curve

 Glue

 Insert

 Gluing surfaces

## Steering A

Glue in order from 1 to 9 on the graphic.

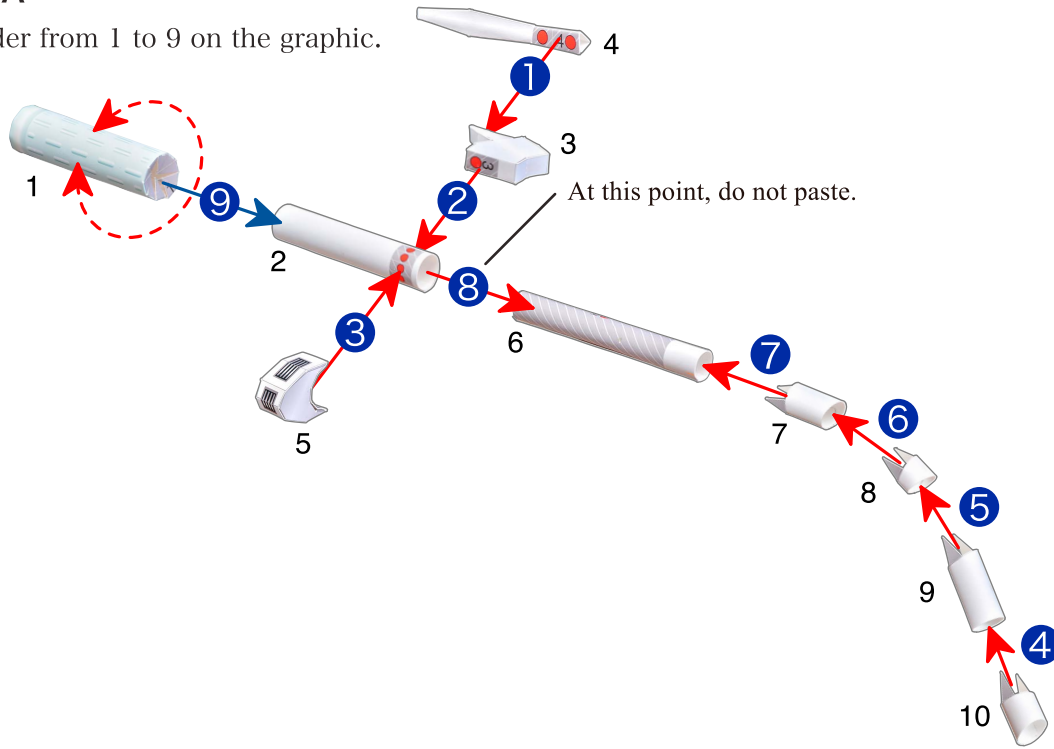

## Steering B

Glue in order from 1 to 17 on the graphic.

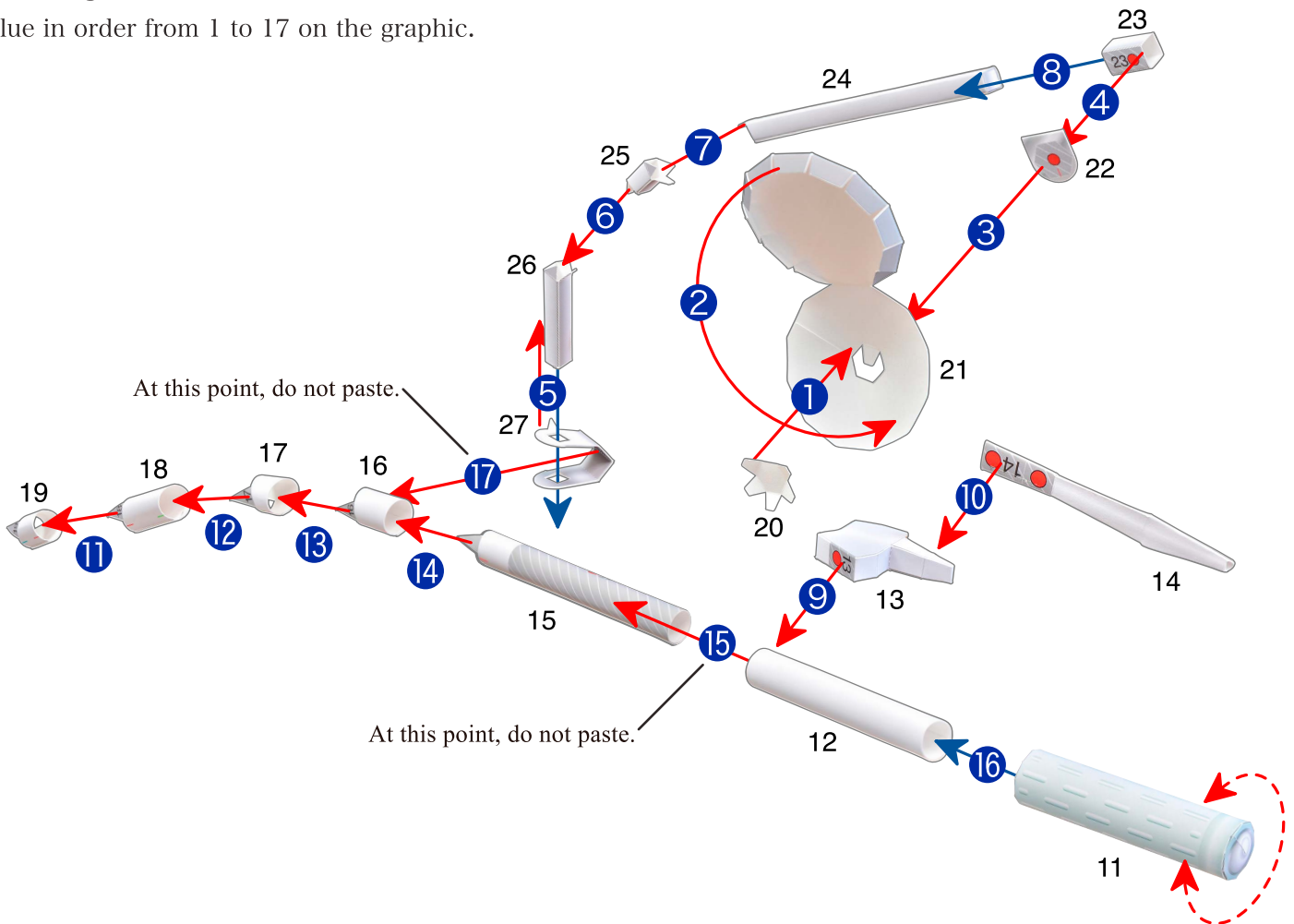

Please refer to the "Basic working method and markings" symbol chart on Page 2 to assemble each part.



### Steering C

Glue in order from 1 to 3 on the graphic.

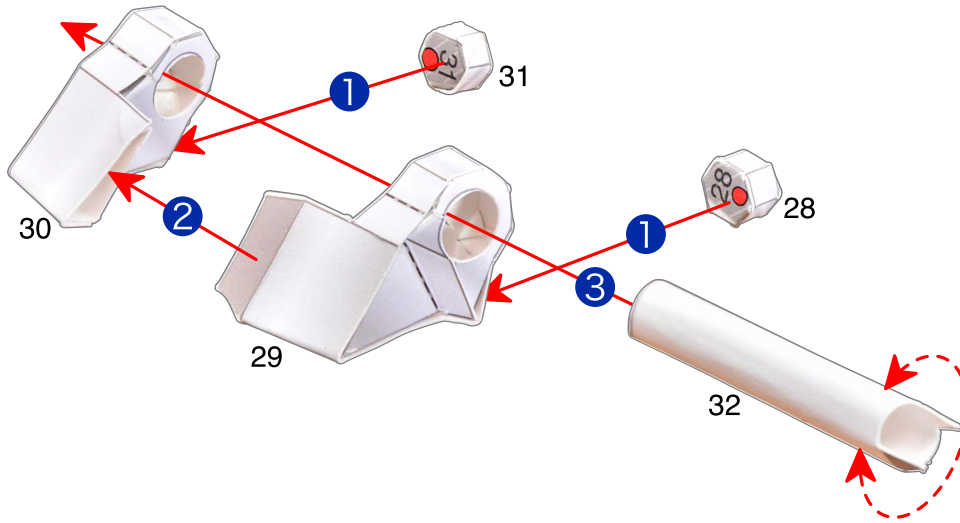

### Steering D

Glue in order from 1 to 3 on the graphic.



### Steering E

Glue in order from 1 to 3 on the graphic.

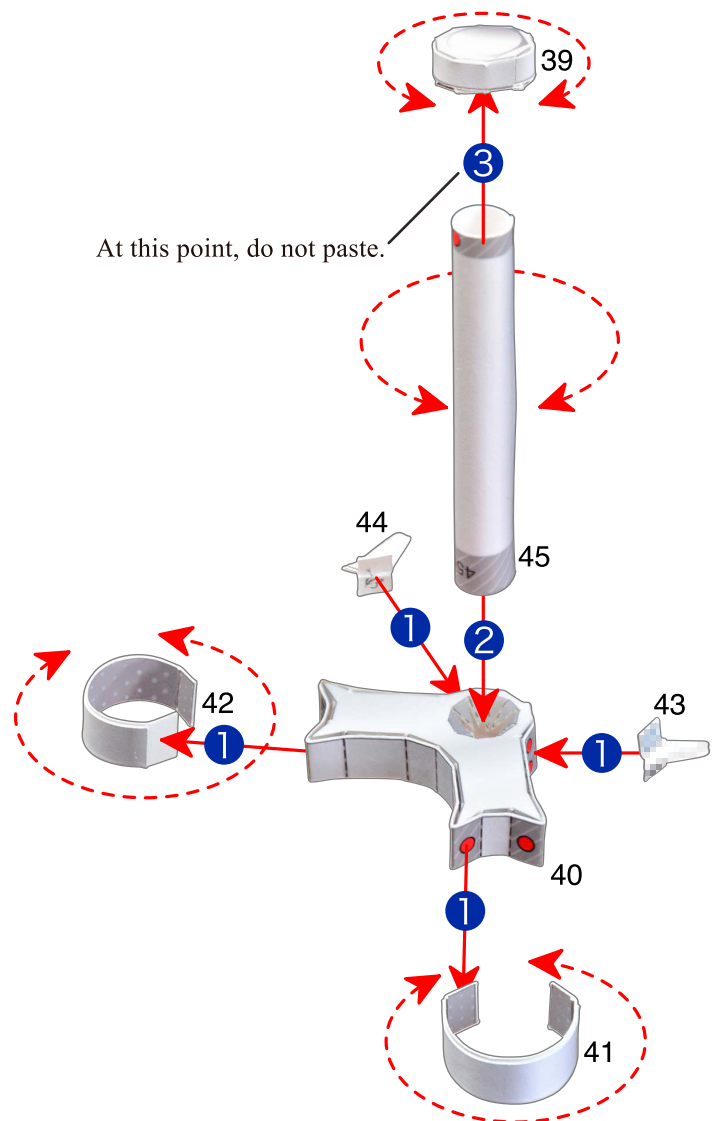

Please refer to the "Basic working method and markings" symbol chart on Page 2 to assemble each part.



### Steering F

\*Assemble both sides.  
The figure shows the right side.  
The numbers inside the ( ) are for the left side.

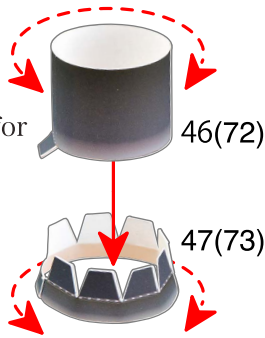

### Steering M

Glue in order from 1 to 2 on the graphic.

\*Assemble both sides.  
The figure shows the right side.  
The numbers inside the ( ) are for the left side.

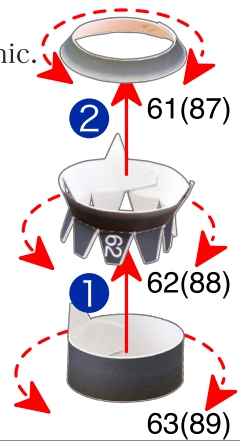

### Steering G

\*Assemble both sides.  
The figure shows the right side.  
The numbers inside the ( ) are for the left side.

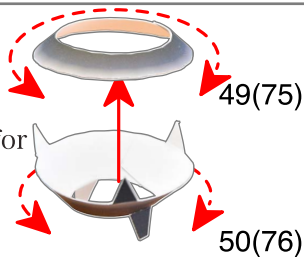

### Steering N

Glue in order from 1 to 2 on the graphic.

\*Assemble both sides.  
The figure shows the right side.  
The numbers inside the ( ) are for the left side.

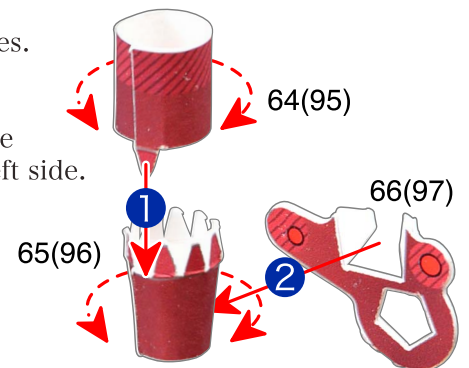

### Steering H

\*Assemble both sides.  
The figure shows the right side.  
The numbers inside the ( ) are for the left side.

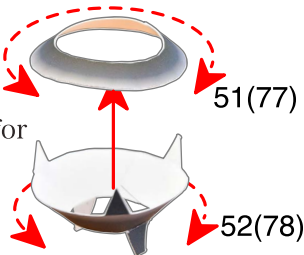

### Steering I

\*Assemble both sides.  
The figure shows the right side.  
The numbers inside the ( ) are for the left side.

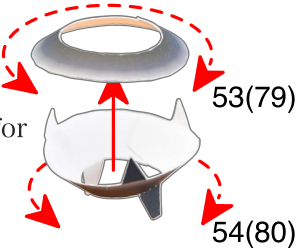

### Steering O

Glue in order from 1 to 2 on the graphic.

\*Assemble both sides. The figure shows the right side.  
The numbers inside the ( ) are for the left side.

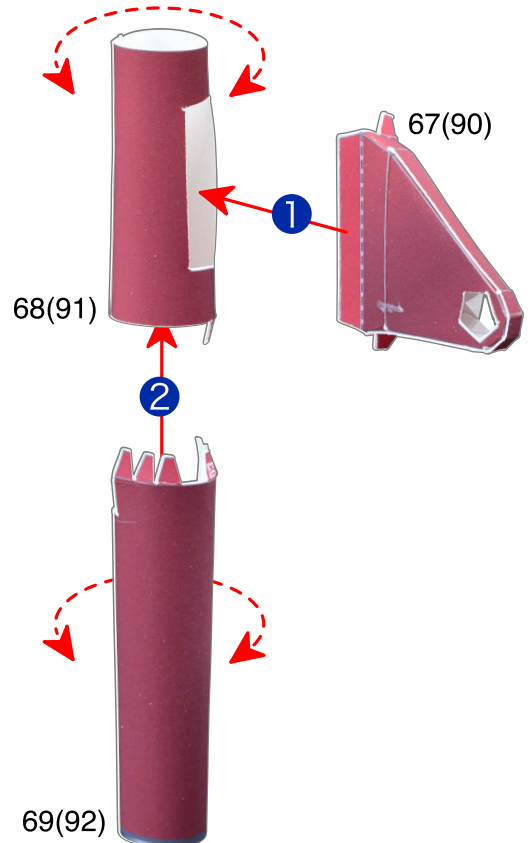

### Steering J

\*Assemble both sides.  
The figure shows the right side.  
The numbers inside the ( ) are for the left side.

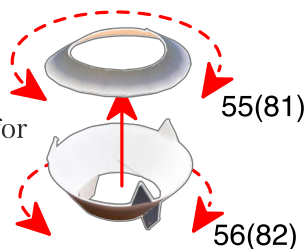

### Steering K

\*Assemble both sides.  
The figure shows the right side.  
The numbers inside the ( ) are for the left side.

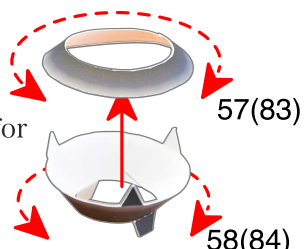

### Steering L

\*Assemble both sides.  
The figure shows the right side.  
The numbers inside the ( ) are for the left side.

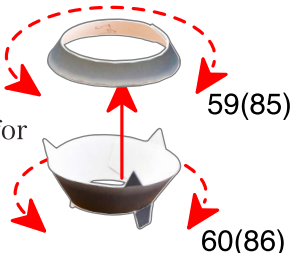



# 3 Assembly of the Front Fender

Please refer to the "Basic working method and markings" symbol chart on Page 2 to assemble each part.



## Front Fender A

\*Assemble both sides. The diagram shows the left side. The number inside the ( ) is for the right side.



## Front Fender B

\*Assemble both sides. The diagram shows the left side. The number inside the ( ) is for the right side.

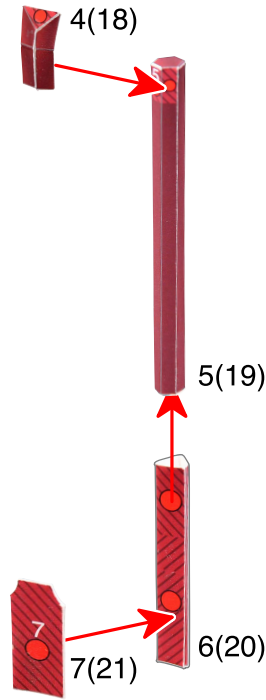

## Front Fender C

\*Assemble both sides. The diagram shows the left side. The number inside the ( ) is for the right side.

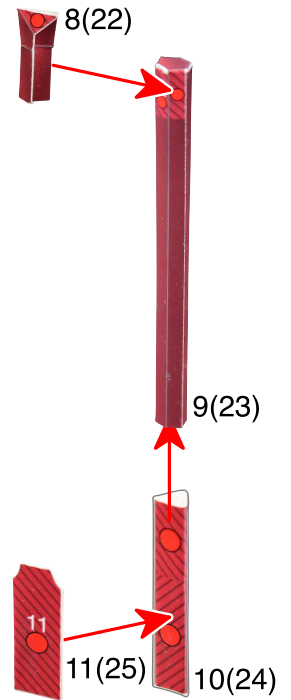

## Front Fender D

Glue in order from 1 to 5 on the graphic.

\*Assemble both sides. The diagram shows the left side. The number inside the ( ) is for the right side.

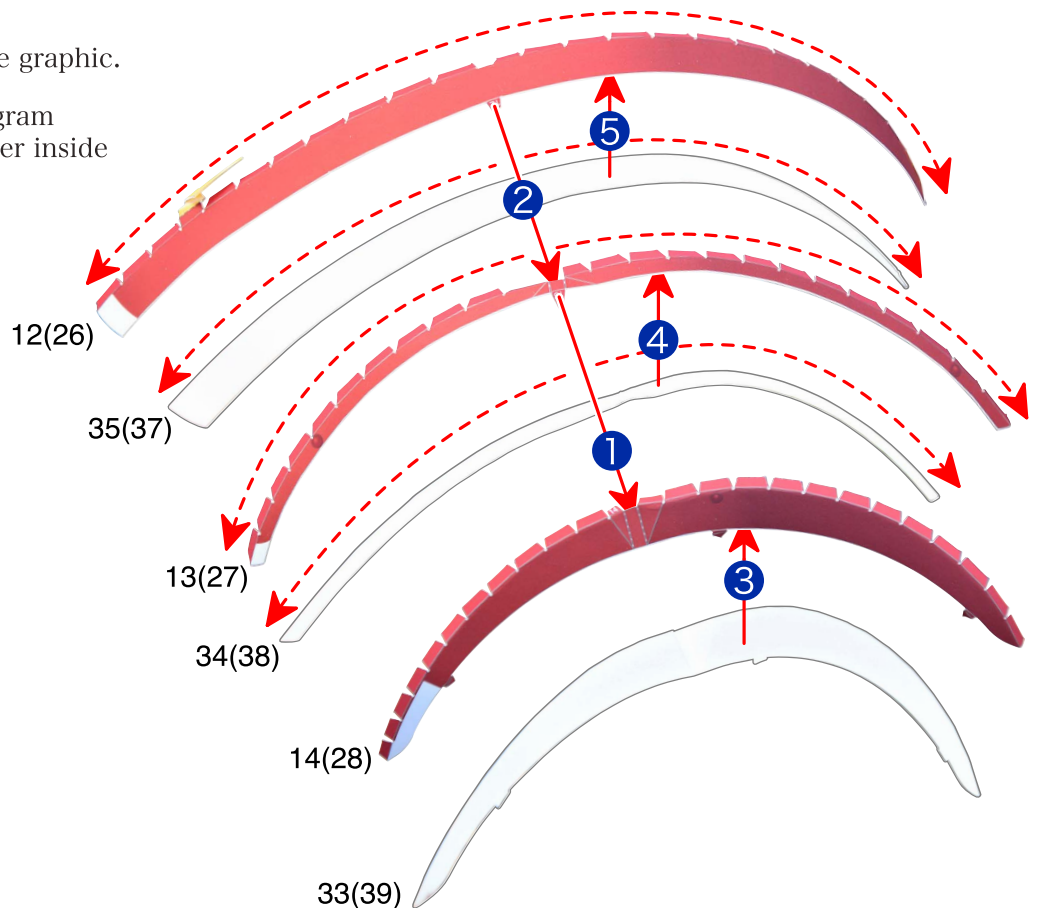



Please refer to the “Basic working method and markings” symbol chart on Page 2 to assemble each part.

Fold or Curve

Glue

Insert

Gluing surfaces

Glue in order from 1 to 6 on the graphic.

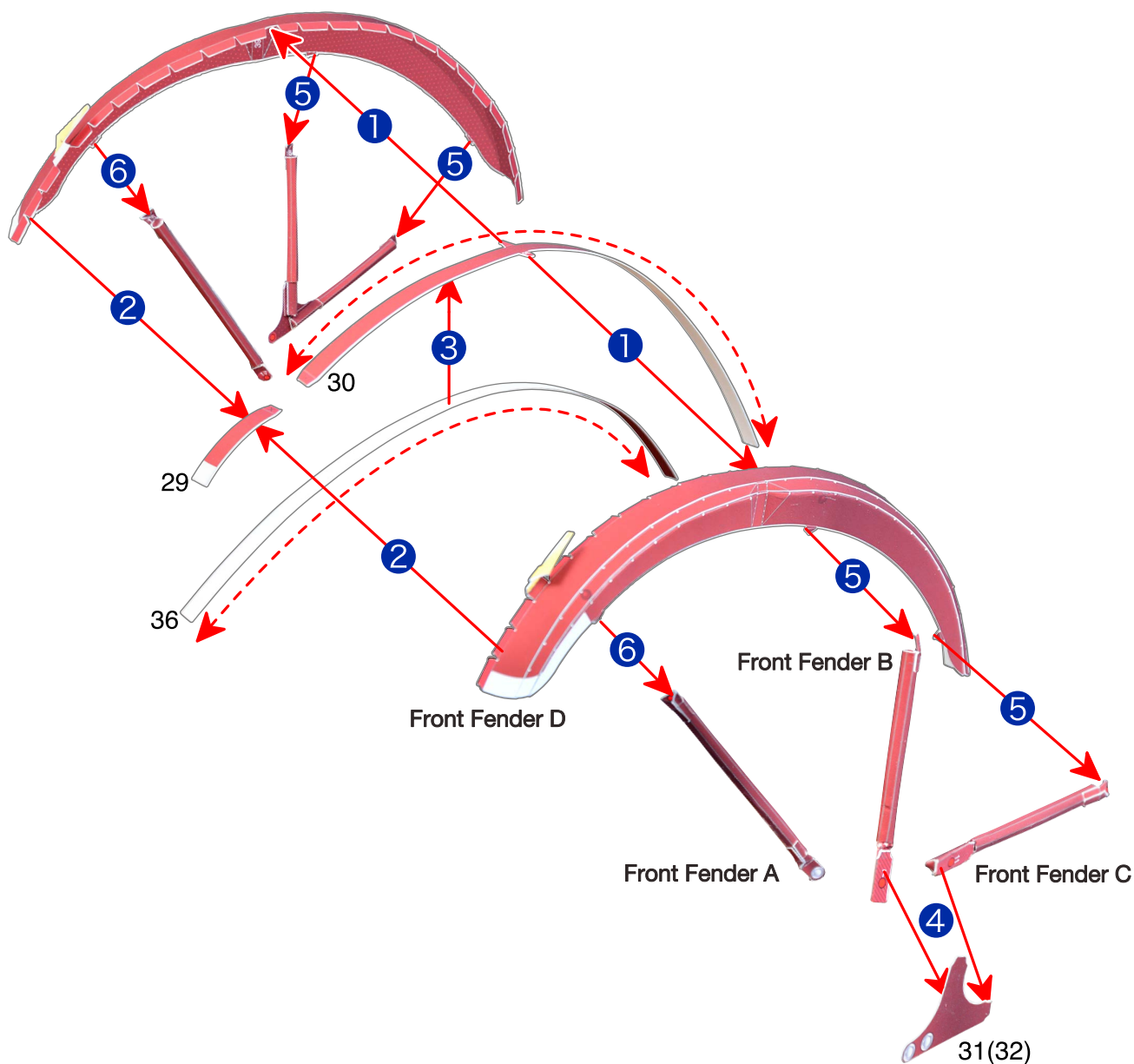

〈 Reference photo 〉



# 3 Assembly of the Saddle

Please refer to the "Basic working method and markings" symbol chart on Page 2 to assemble each part.



## Saddle A

Glue in order from 1 to 3 on the graphic.

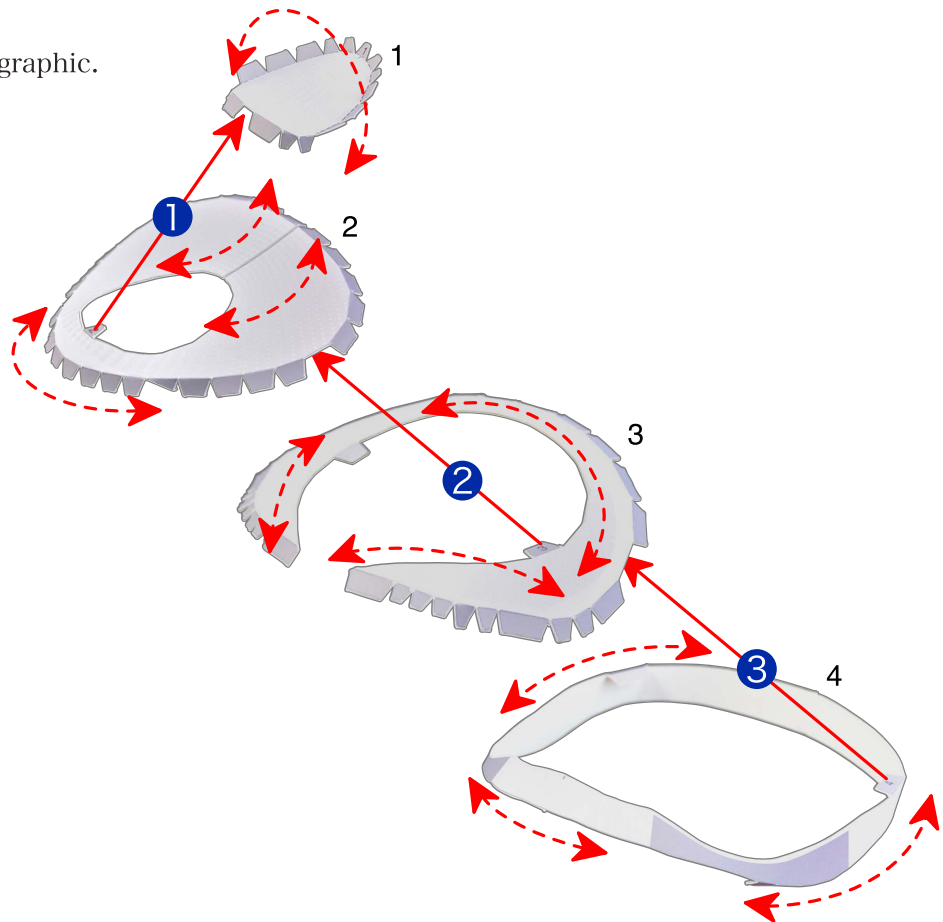

## Saddle B

Glue in order from 1 to 3 on the graphic.

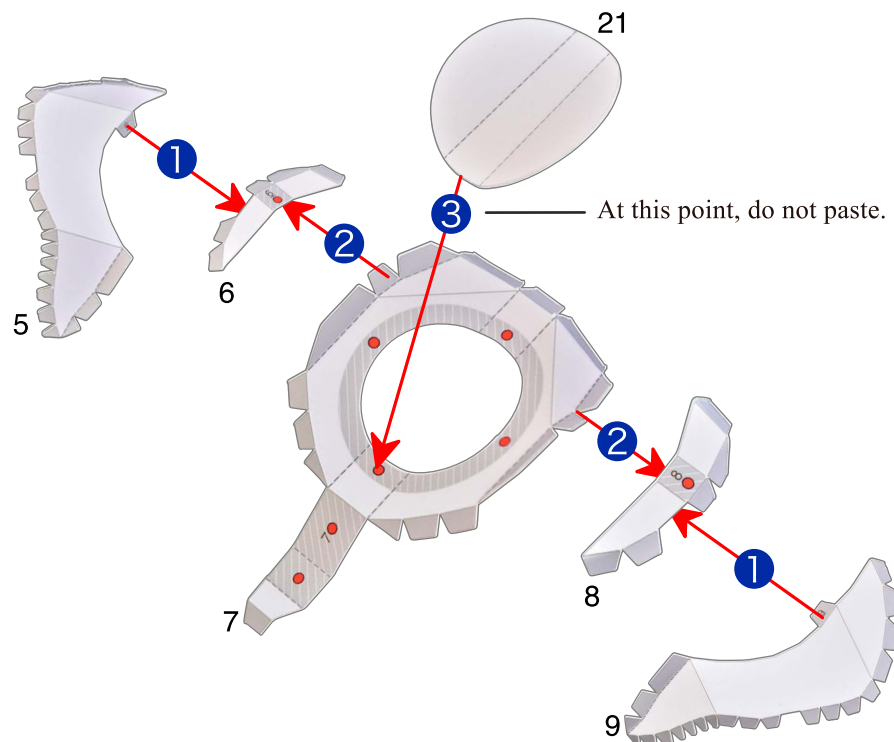

Please refer to the “Basic working method and markings” symbol chart on Page 2 to assemble each part.

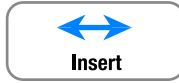

### Saddle C

Glue in order from 1 to 3 on the graphic.

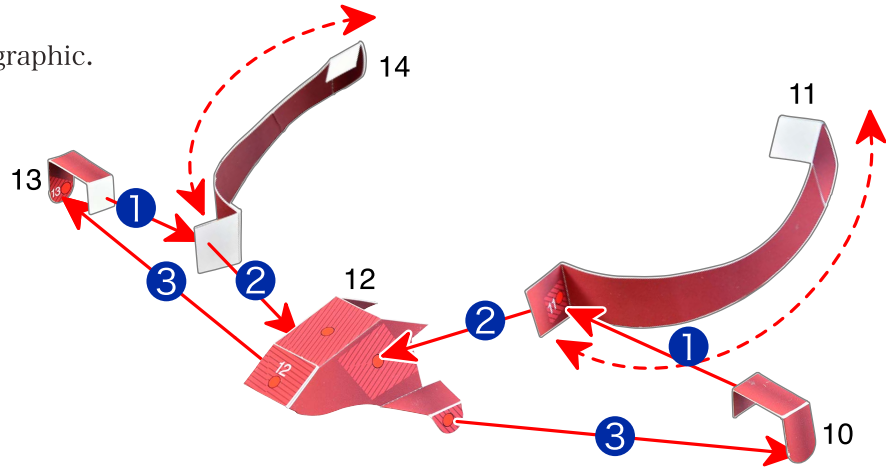

### Saddle D

Glue in order from 1 to 2 on the graphic.

\*Assemble both sides. The diagram shows the left side. The number inside the ( ) is for the right side.

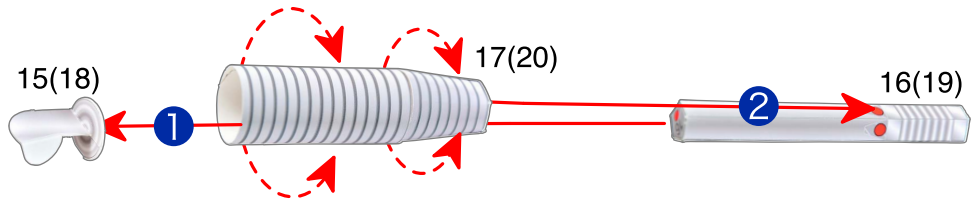

Glue in order from 1 to 4 on the graphic.

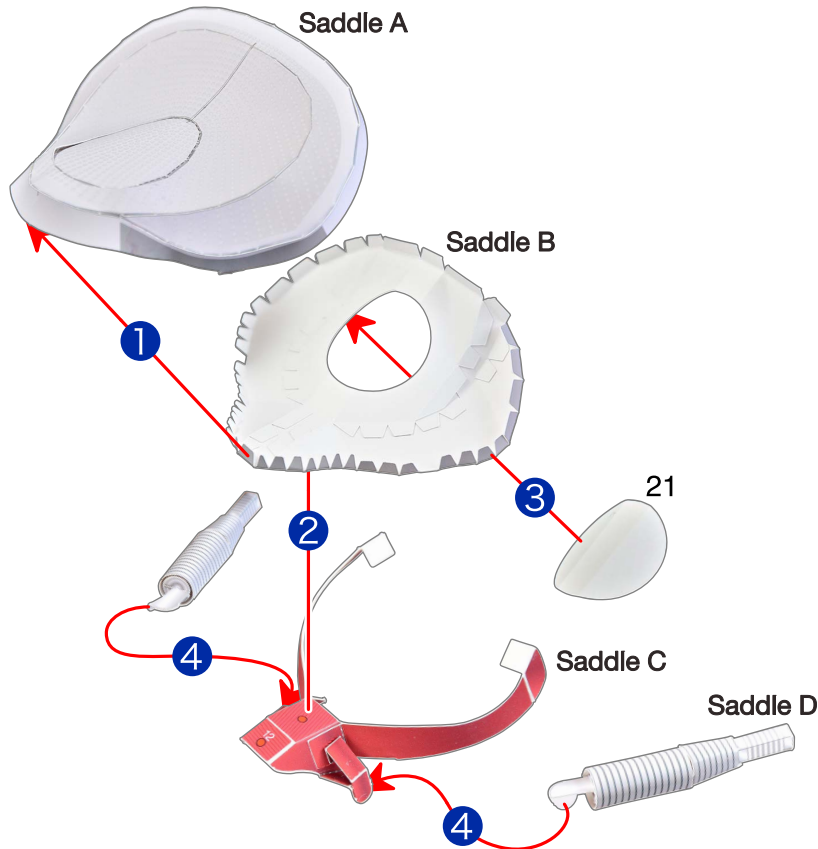

〈 Reference photo 〉



# 3 Assembly of the Frame

Please refer to the "Basic working method and markings" symbol chart on Page 2 to assemble each part.

|               |      |        |                 |
|---------------|------|--------|-----------------|
| Fold or Curve | Glue | Insert | Gluing surfaces |
|---------------|------|--------|-----------------|

## Frame A

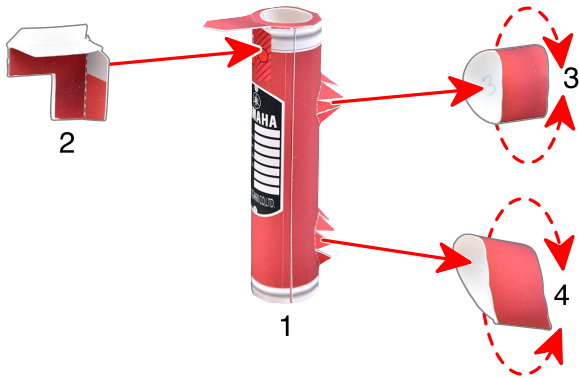

## Frame B

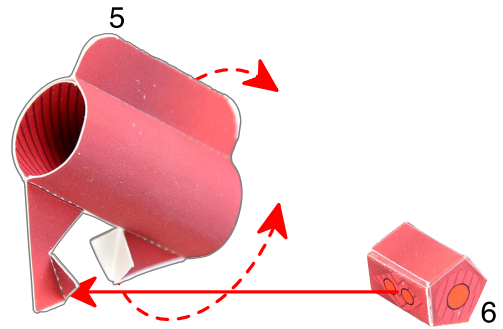

## Frame C

Glue in order from 1 to 11 on the graphic.

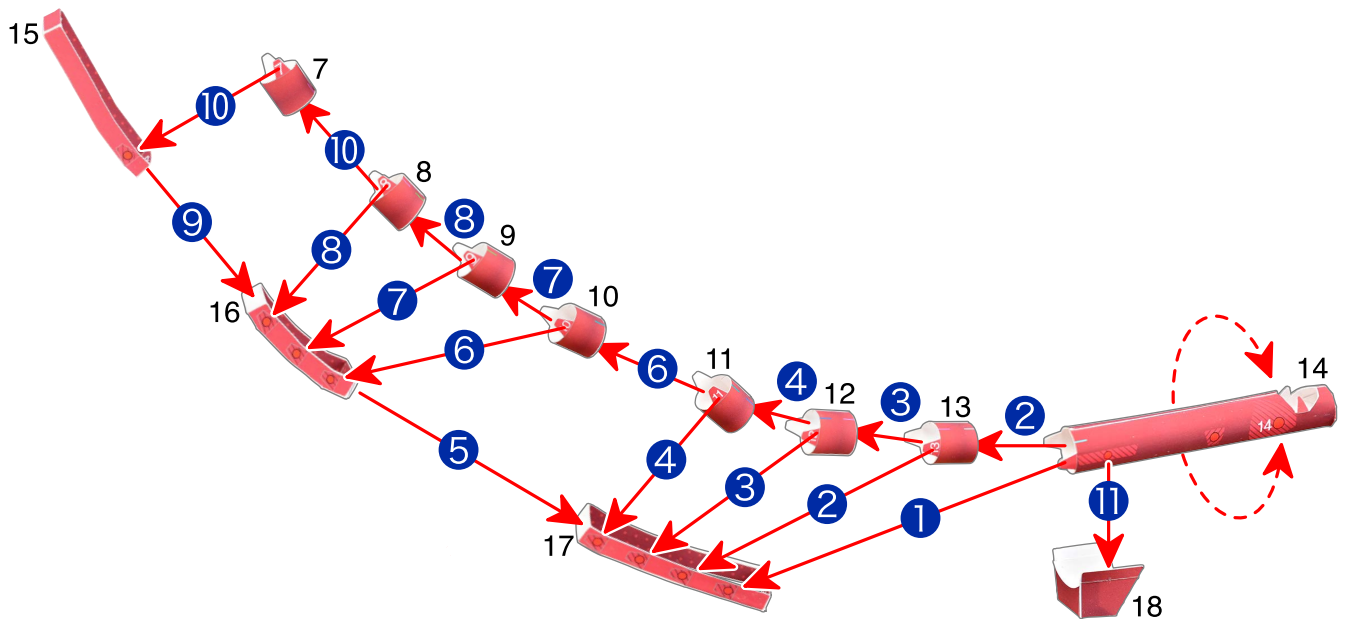

## Frame D

Glue in order from 1 to 4 on the graphic.

\*Assemble both sides. The diagram shows the left side. The number inside the ( ) is for the right side.

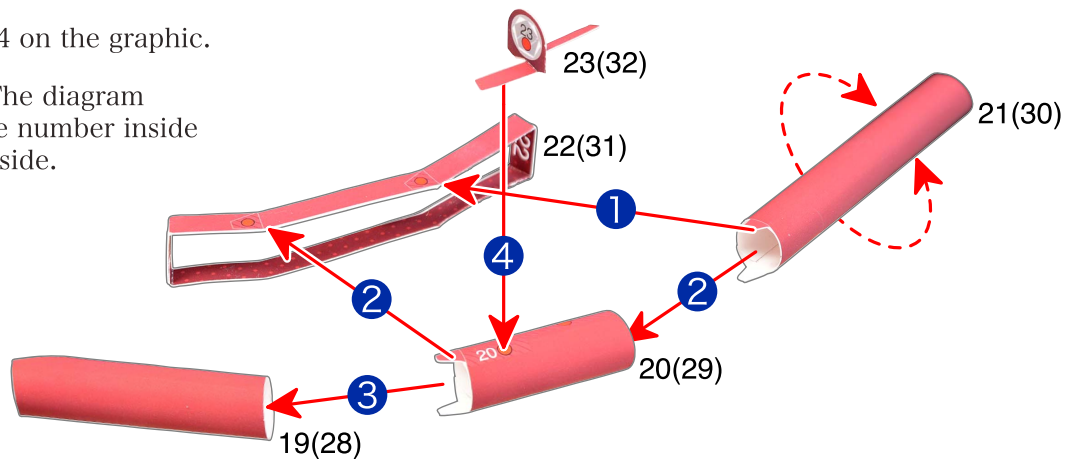

Please refer to the "Basic working method and markings" symbol chart on Page 2 to assemble each part.



### Frame E

Glue in order from 1 to 3 on the graphic.

\*Assemble both sides. The diagram shows the left side. The number inside the ( ) is for the right side.

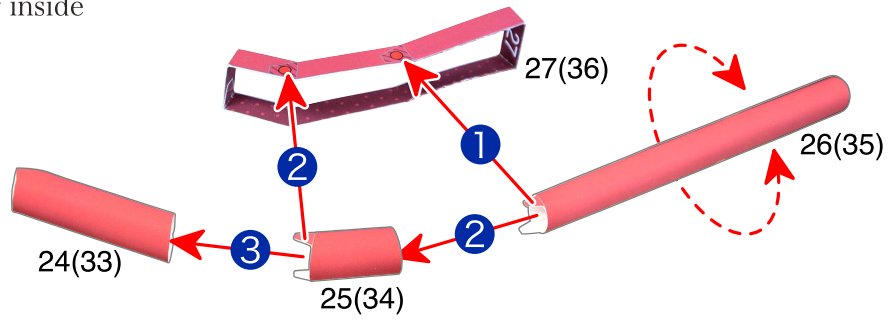

### Frame F

Glue in order from 1 to 2 on the graphic.

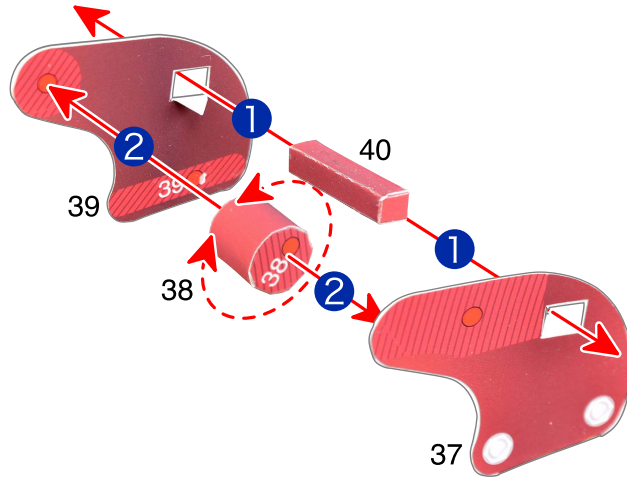

### Battery

Glue in order from 1 to 5 on the graphic.

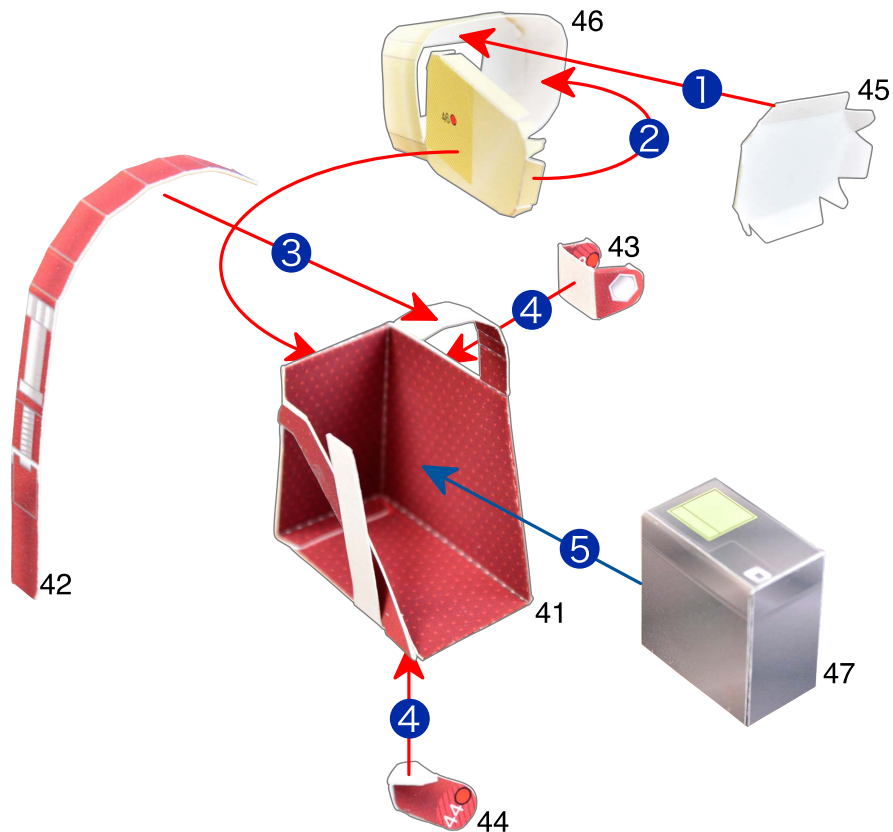

Please refer to the "Basic working method and markings" symbol chart on Page 2 to assemble each part.



## Rear Brake A

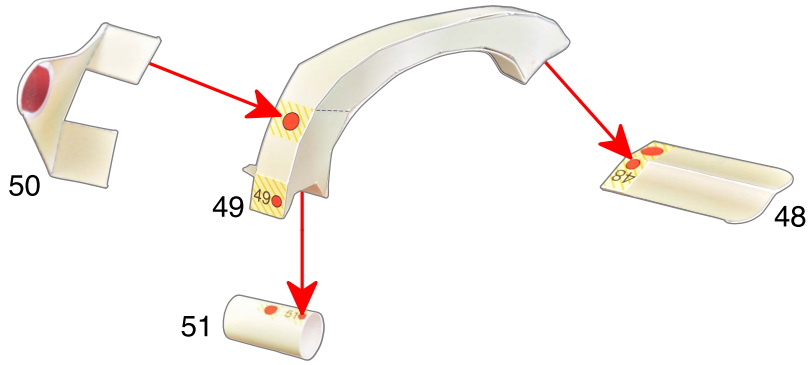

## Footrest Gums

\*Assemble both sides. The diagram shows the left side. The number inside the ( ) is for the right side.

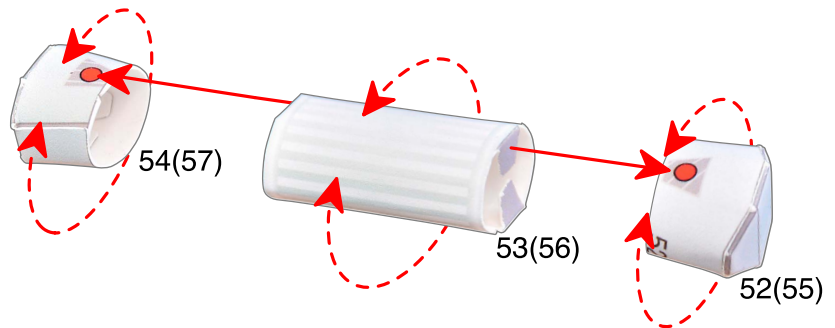

## Stand

Glue in order from 1 to 12 on the graphic.

\*Assemble both sides. The diagram shows the left side. The number inside the ( ) is for the right side.

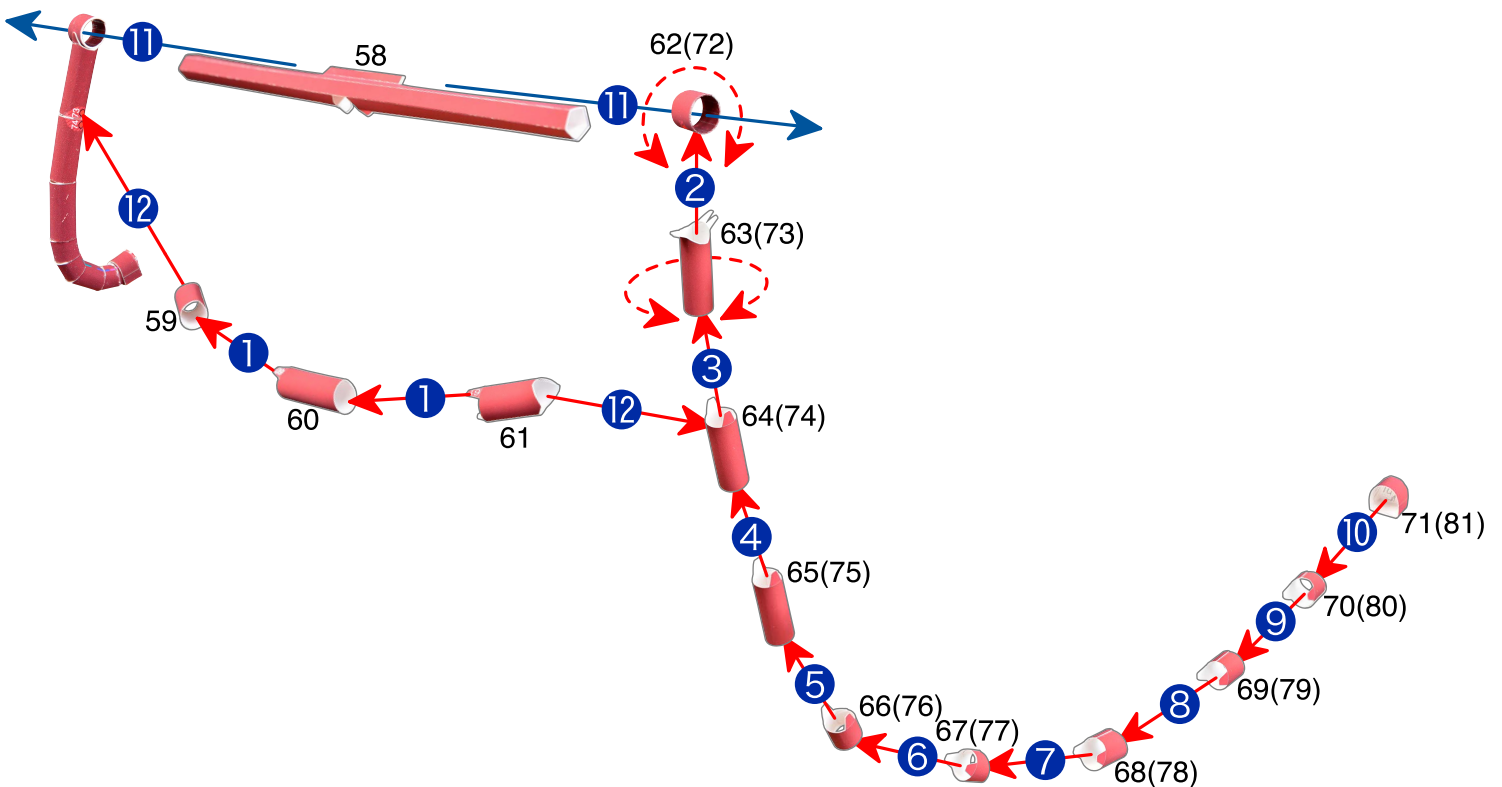

Please refer to the “Basic working method and markings” symbol chart on Page 2 to assemble each part.



Glue in order from 1 to 12 on the graphic.

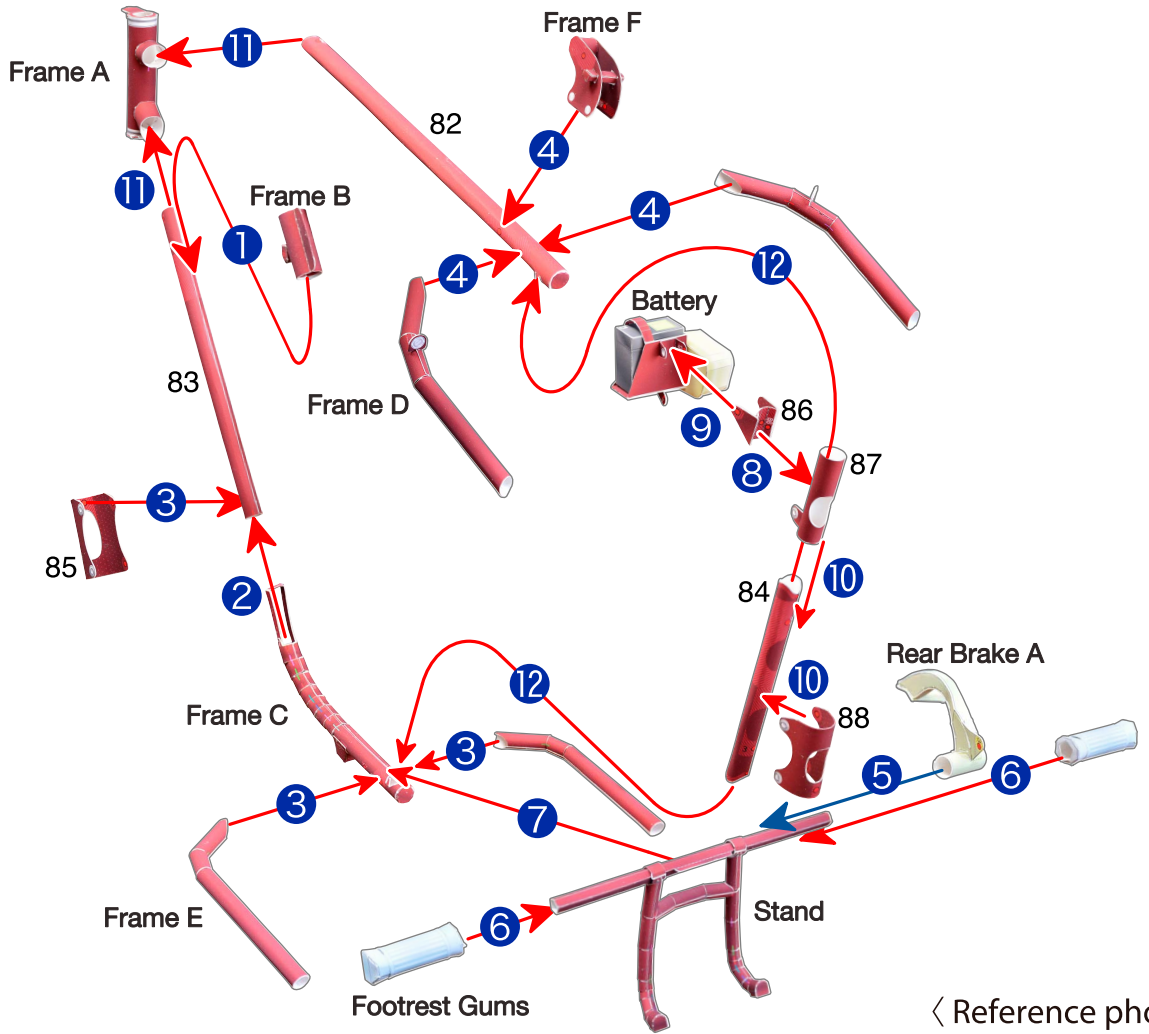

< Reference photo >



# 3 Assembly of the Rear Cushions

Please refer to the "Basic working method and markings" symbol chart on Page 2 to assemble each part.



## Rear Cushions

Glue in order from 1 to 10 on the graphic.

\*Assemble both sides. The diagram shows the left side. The number inside the ( ) is for the right side.

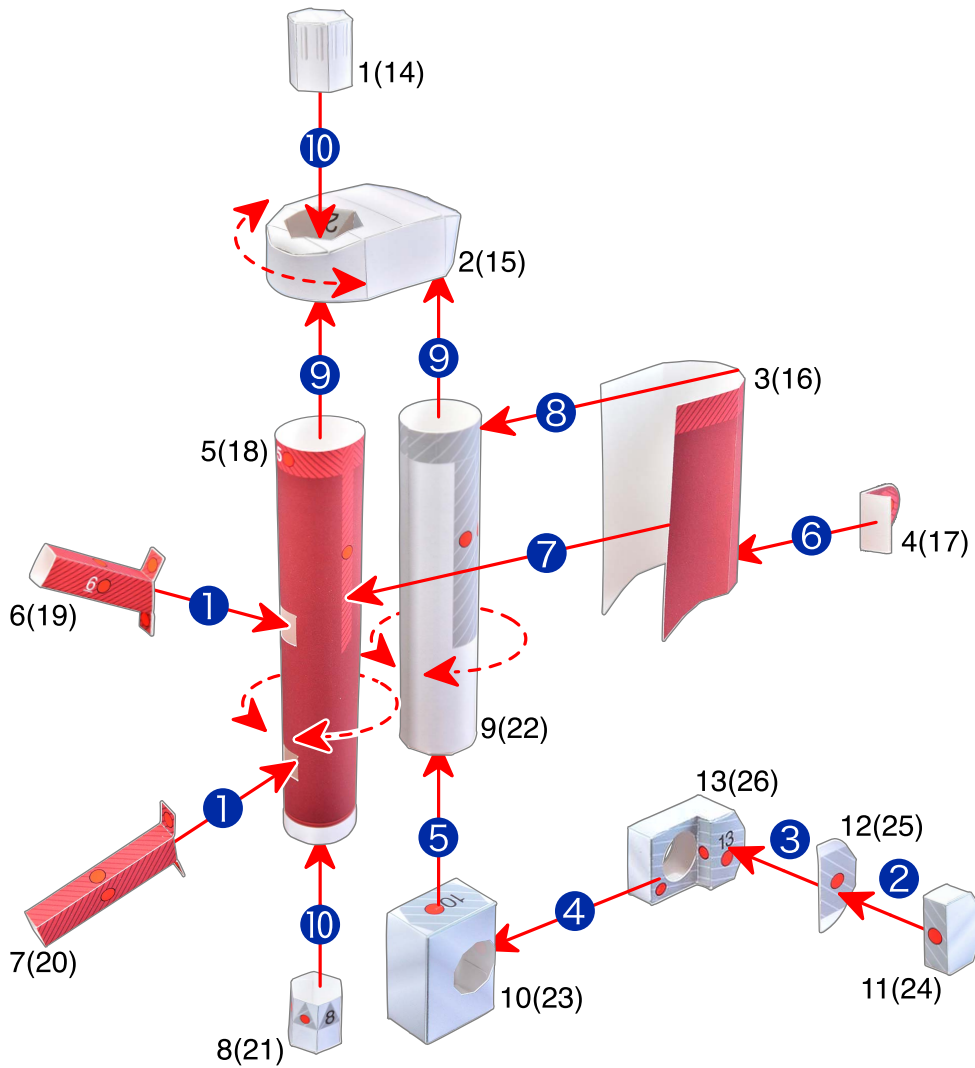

< Reference photo >

